

MOBIRO.

Pasul 6 (Montaj Agatator Pt. sina)

Se monteaza pe laterale (2) si (3)
2x Agatatori pentru sina (Ag) folosindu-se
suruburi 3.5x30 (S6) - cate 2 / agatator

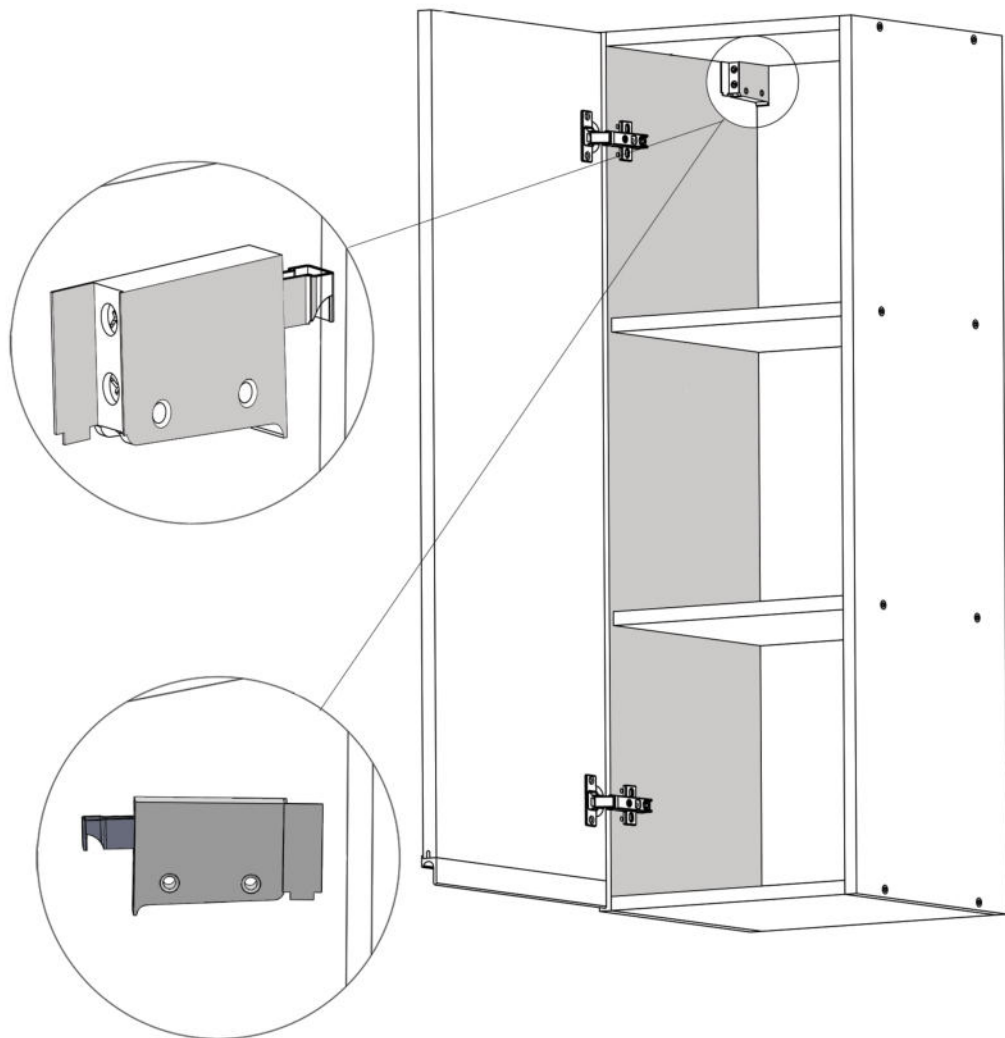

MOBIRO.

Instrucțiuni montaj: Corp Superior (1000)- 300 mm

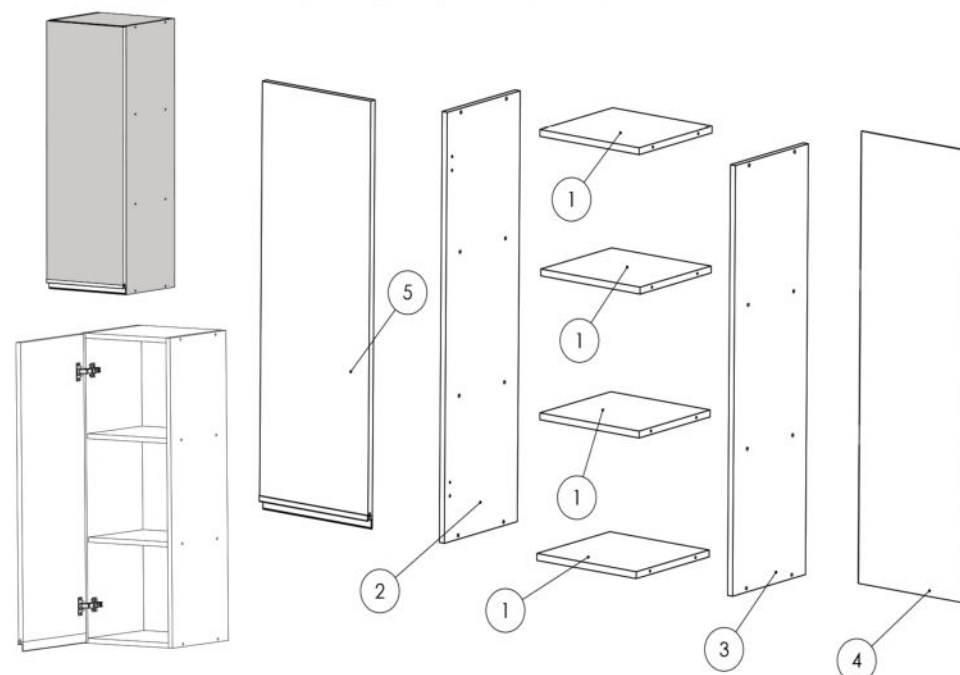

NR REPER	DETALII	COD REPER	CANTITATE
1	268X308X16	FUND/TAVAN/POLITA	4
2	1000X308X16	LATERALA STANGA	1
3	1000X308X16	LATERALA DREAPTA	1
4	995X297X2.5	HDF ALB	3
5	996X297X18	FRONT ST/DR	1

ATENȚIE: MONTAJUL NECORESPUNZĂTOR ATRAGE DUPĂ SINE PIERDEREA GARANȚIEI PRODUSULUI



Șurubelniță în cruce
sau autofiletantă



Este **recomandat** ca
montajul să fie făcut de
minim două persoane



Un **ciocan** de dimensiune
medie

MOBIRO.

CONFIRMATOR 50mm Co  16	SURUB 4X18 S8  8	SURUB 3.5X30 S6  16	SURUB M4X22 Sm  2
CIUIE Cu  40	BALAMALE APLICATE Ba  2	SAIBE TIP CUPA Sc  10	COLTAR PLASTIC PVC ALB Ag  2

Pasul 1

Se prinde placa (2) si (3) de placile (1) cu ajutorul a celor 16 x Confirmatoare (Co)

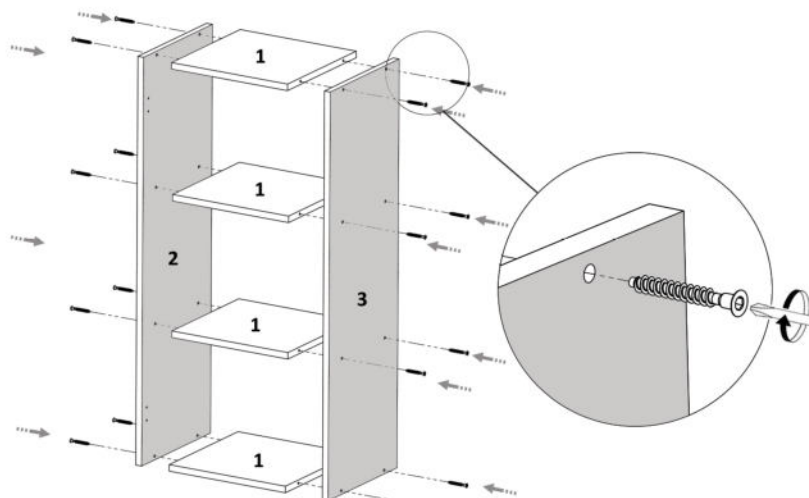

Se masoara diagonalele sa fie in vinclu, dupa care se prinde HDF-ul (4) folosindu-se de ciocan cu ajutorul unor cuie (Cu)x 40 buc.

 Se masoara diagonalele sa fie in vinclu inainte de a monta HDF-ul!

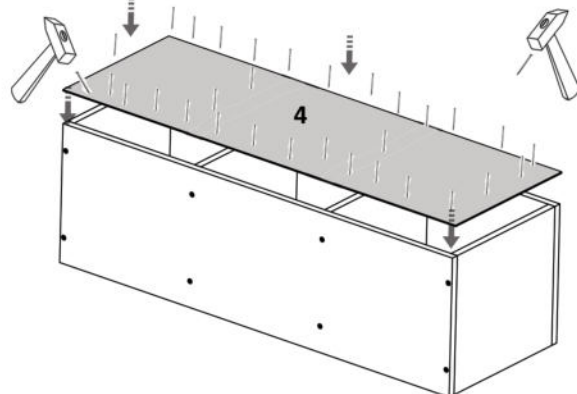

MOBIRO.

Pasul 4 (Montaj Balamale)

Se monteaza pe placa Front (5) si pe laterala (2) balamale (Ba) 2x balamale folosindu-se suruburi 4x18 (S8) - cate 4 / balama

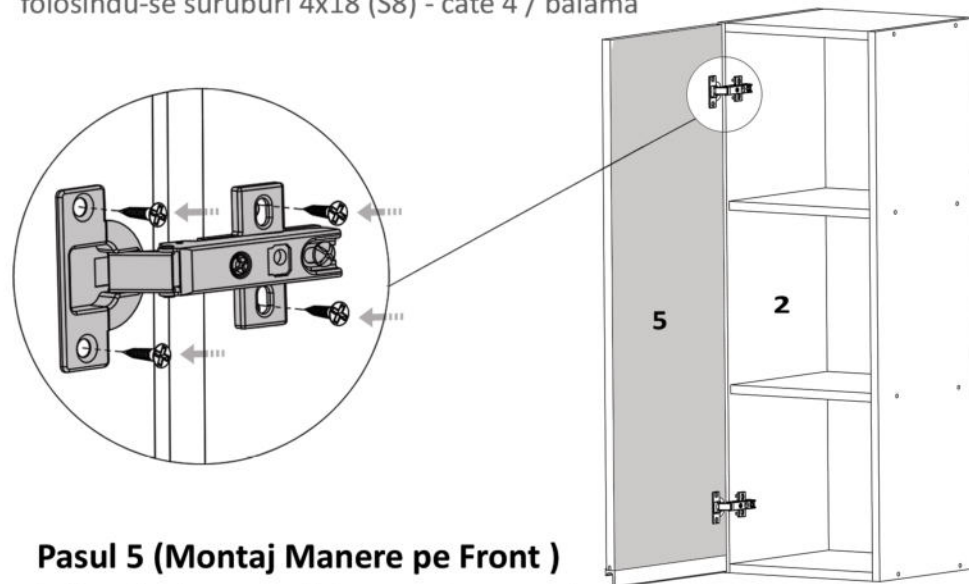

Pasul 5 (Montaj Manere pe Front)

In functie de manerul ales, acesta se monteaza pe placa Front (5) 1x maner folosindu-se suruburi M4x22 (Sm) - cate 2 / maner.

 Inainte de a monta manerele, Se gauresc Usile cu diam. de 5 in semnele de pe acestea.

