

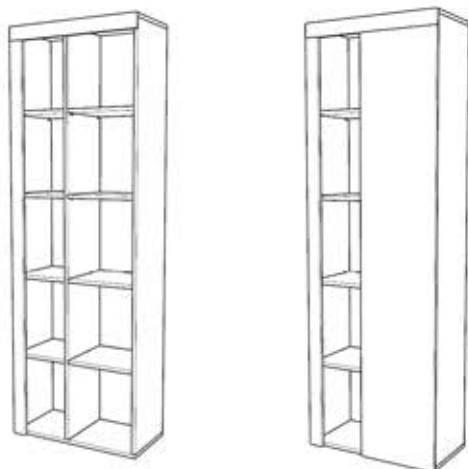

RO INSTRUCTIUNI DE MONTAJ
EN INSTALLATION INSTRUCTIONS
DE INSTALLATIONSANLEITUNG
FR INSTRUCTIONS D'INSTALLATION
IT ISTRUZIONI PER L'INSTALLAZIONE
HU SZERELÉSI ÚTMUTATÓ
UKR ІНСТРУКЦІЇ ДО МОНТАЖУ
SRB УПУТСТВО ЗА МОНТАЖ
BG ИНСТРУКЦИИ ЗА МОНТАЖ
RUS ИНСТРУКЦИИ ДО МОНТАЖУ



Denumire	Dimensiune	Bucati	Simbol
Tavan	600 288	1	T
Fund	600 288	1	F
Laterale	1768 288	2	L
Lezena 1	600 60	1	LZ
Lezena 2	1740 60	1	LZ
Polite	306 288	4	P
Polite	246 288	4	P
Intermediara	1768 288	1	IM
Front	1736 336	1	F

Picioare plastic gri Pi 4	Culute C 66	Confirmatoare CF 12
Support Polita SP 32	Balamale Aplicare BA 3	Coltar Plastic CP 7
Surub 3.5x16 S5 12	Surub 4x16 S4 14	Surub M4x22 S7 2
Saiba Cupa SC 18	Mansor M 1	Surub 5x25 S6 8

1 Montare

Se fixeaza pe fund cele 3 piese (laterale si intermediara), iar apoi se fixeaza tavanul.
Picioarele de plastic gri (Pi) x 4buc se monteaza pe placa Fund (F) cu suruburi (S6) x 8 buc - cate 2 / picior.

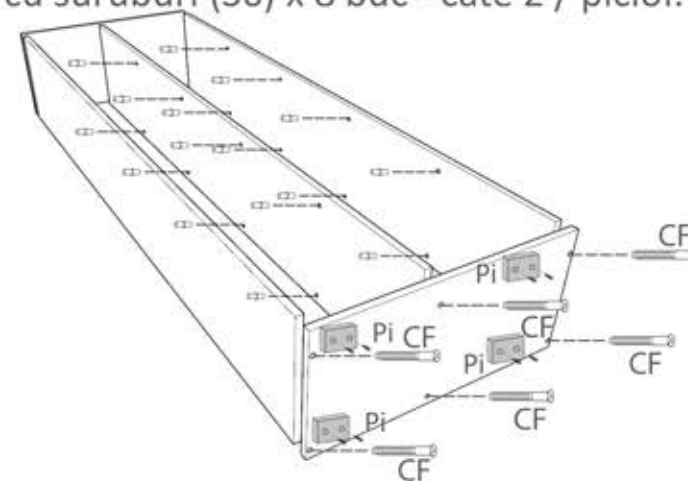

Se monteaza suportii de polita precum este reprezentat in cele doua desene.

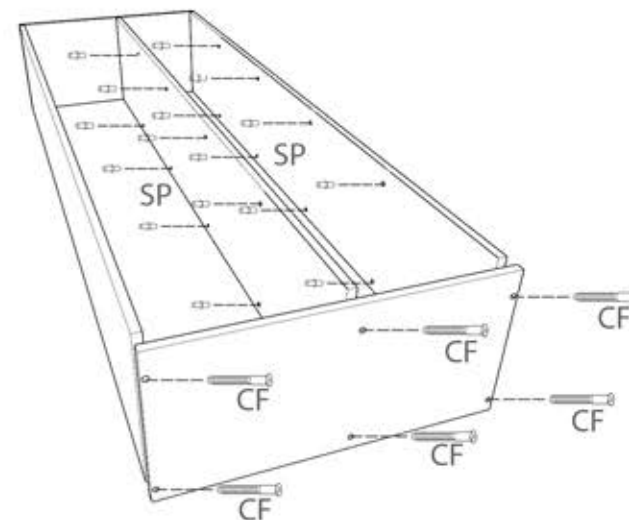

2 Montare HDF

Important! Inainte de a prinde HDF-ul de partea din spate a dulapului, acesta trebuie adus in vinclu, adica la 90 de grade.

Se va intoarce dulapul cu cantul spre podea, va ramane in pozitie orizontala, apoi se va prinde HDF-ul cu cuiute (C) si cu ajutorul saibelor cupa (SC).

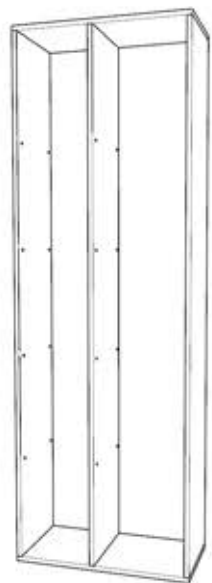

Dupa prinderea HDF-ului, se aseaza politele mobile pe suporti de polita (SP).

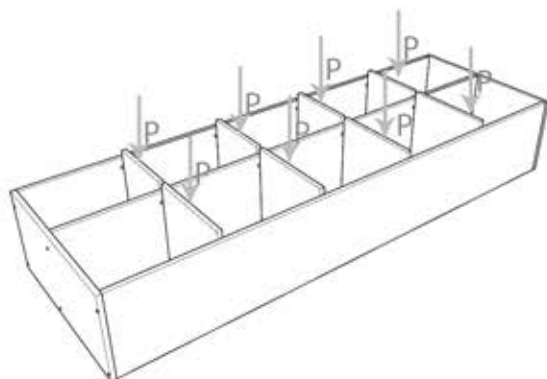

3 Montare lezene si front

Lezenele se monteaza cu ajutorul coltarelor de plastic (CP) care se prind din interiorul dulapului. Coltarele de plastic se vor fixa de laterala si lezna cu surub 4x16(S4).

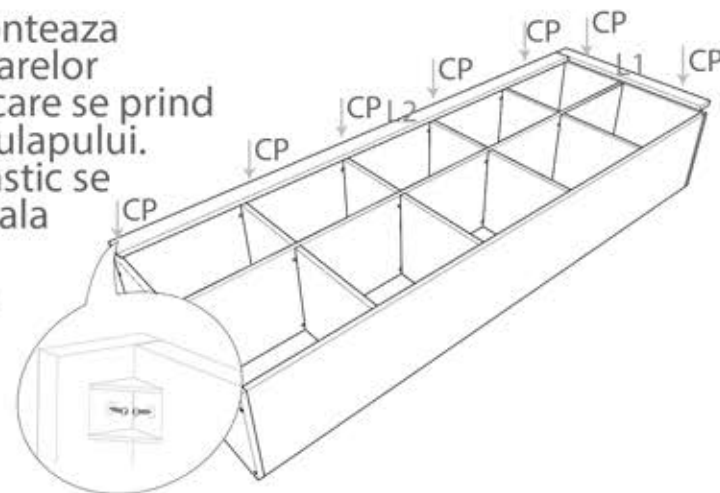

Prinderea balamalelor pe usi se face ca in desenul de mai jos.

Pentru prinderea balamalelor (BA) se vor folosi suruburile 3.5x16 (S5).

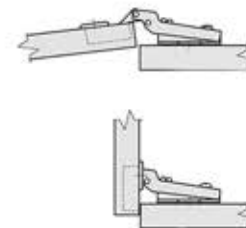
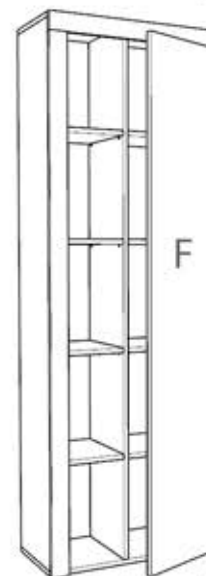

Se regleaza cu ajutorul unei surubelnite PZ2, frontul pentru a fi aliniat. Manerul(M) se fixeaza pe front cu ajutorul suruburilor S7