

# MOBIRO.

## Comoda Suspendata

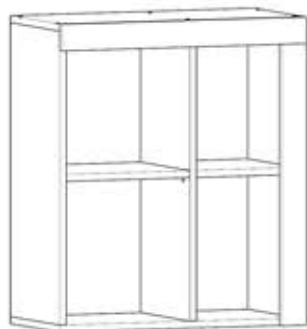

RO INSTRUCTIUNI DE MONTAJ  
EN INSTALLATION INSTRUCTIONS  
DE INSTALLATIONSANLEITUNG  
FR INSTRUCTIONS D'INSTALLATION  
IT ISTRUZIONI PER L'INSTALLAZIONE  
HU SZERELÉSI ÚTMUTATÓ  
UKR ІНСТРУКЦІЇ ДО МОНТАЖУ  
SRB УПУТСТВО ЗА ИЖТАРАЖИЈУ  
BG ИНСТРУКЦИИ ЗА ИЖТАРАЖАНЕ  
RUS ИНСТРУКЦИИ ДО МОНТАЖА

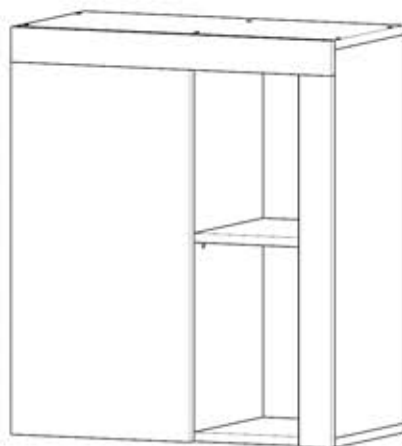

Denumire	Dimensiune	Bucati	Simbol
Tavan	600 288	1	T
Fund	600 288	1	F
Laterale	668 288	2	L
Lezeta 1	600 60	1	LZ
Lezeta 2	640 60	1	LZ
Polite	304 288	1	P
Polite	248 288	1	P
Intermediara	668 288	1	IM
Front	636 336	1	F

Manser		
M		1

Cusute		
C		51

Confirmatoare		
CF		12

Suport Polite		
SP		8

Balamale Aplicare		
BA		2

Coltar Plastic		
CP		4

Surub 3.5x16		
S5		8

Surub 4x16		
S4		8

Surub 4x30		
S3		2

### 1 Montare

Se fixeaza pe fund cele 3 piese (laterale si intermediara), iar apoi se fixeaza tavanul.

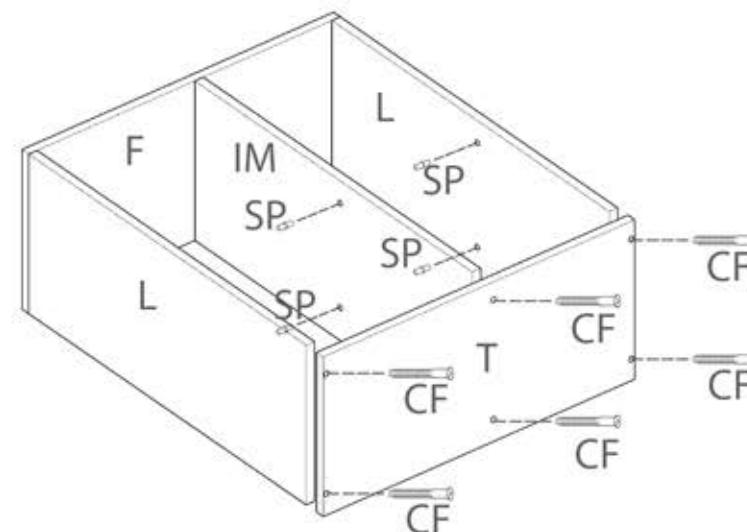
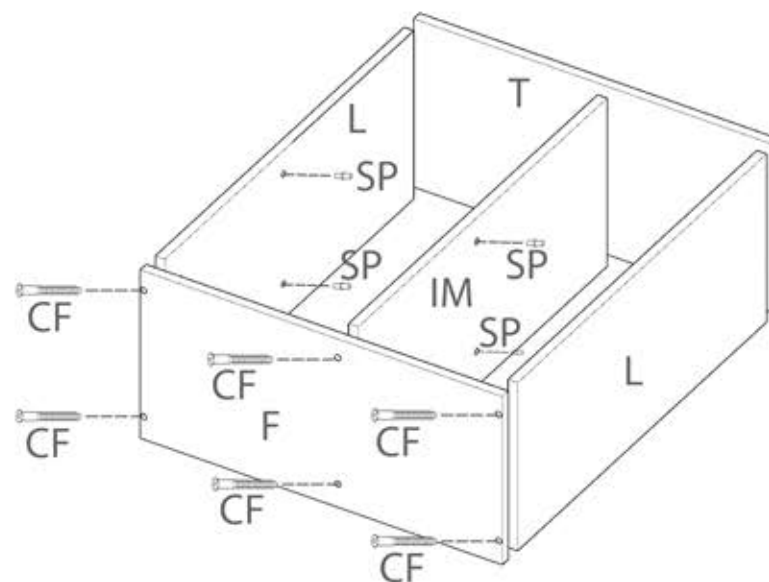

### 2 Montare HDF

**Important!** Inainte de a prinde HDF-ul de partea din spate a dulapului, acesta trebuie adus in vinclu, adica la 90 de grade.  
Se va intoarce dulapul cu cantul spre podea, va ramane in pozitie orizontala, apoi se va prinde HDF-ul cu cuiute (C).

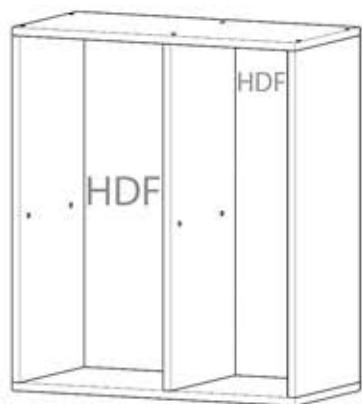

Dupa prinderea HDF-ului, se aseaza politele mobile pe suporti de polita (SP).

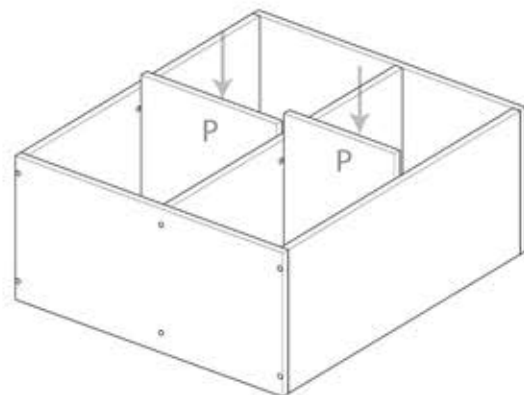

### 3 Montare lezene si front

Lezenele se monteaza cu ajutorul coltarelor de plastic (CP) care se prind din interiorul dulapului. Coltarele de plastic se vor fixa de laterala si lezna cu surub 3,5x16(S5).

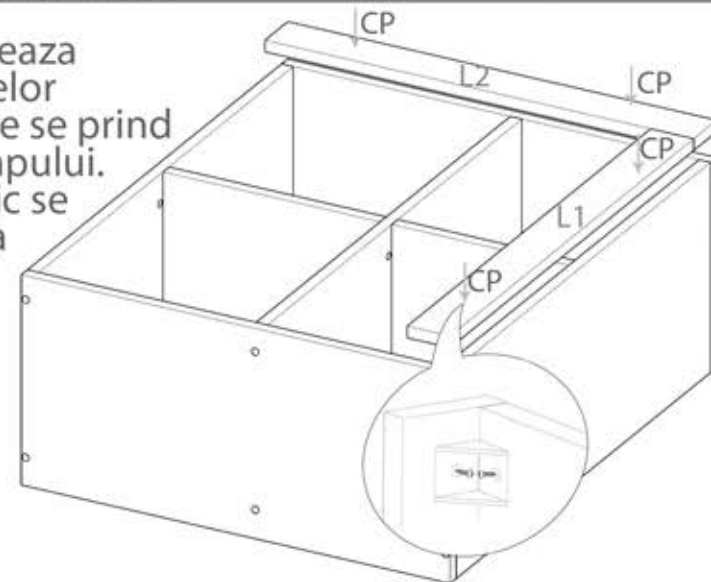

Prinderea balamalelor pe usi se face ca in desenul de mai jos.

Pentru prinderea balamalelor (BA) se vor folosi suruburile 3.5x16 ( S5 ).

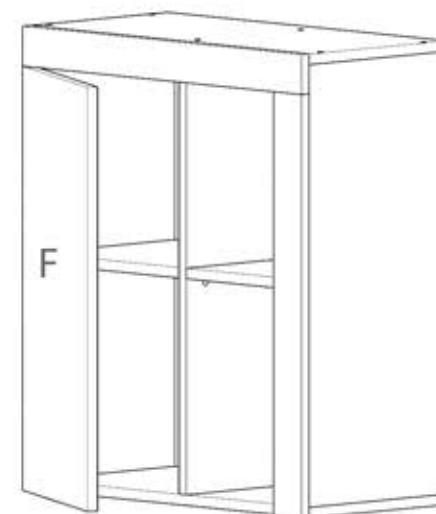
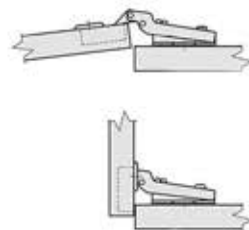

Se regleaza cu ajutorul unei surubelnite PZ2, frontul pentru a fi aliniat.  
Manerul(M) se fixeaza pe front cu ajutorul suruburilor S3.