

Pasul 5 (Montaj Sertare) x 2 BUC

Se monteaza placile (8) si (9) pe placa (7) cu ajutorul suruburilor (S6) 3.5x40, cate 2 buc / placa, in gaurile realizate pentru acestea.



Pasul 6 (Montaj Sertare) x 2 BUC

Se prinde placa Front (10) de placa (8) si (9) cu demontabili (De) x 2 buc in gaurile prestabilite, urmand ca apoi sa se infleteze (Ca)x 2 buc pana acestea raman stranse.

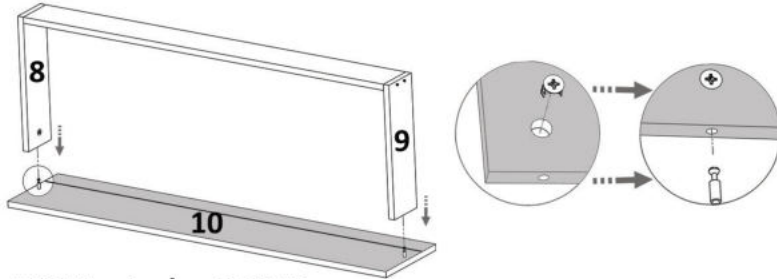

Pasul 7 (Montaj HDF Sertar) x 2 BUC

Se masoara diagonalele sa fie in vinclu, dupa care se prinde HDF-ul (11) folosindu-se de ciocan cu ajutorul unor cuie (Cu)x 22 buc. HDF-ul trebuie positionat si introdus in locasul acestuia de pe placa (10).



Pasul 8 (Montaj Glisiera Stanga / Dreapta Sertar) x2 BUC

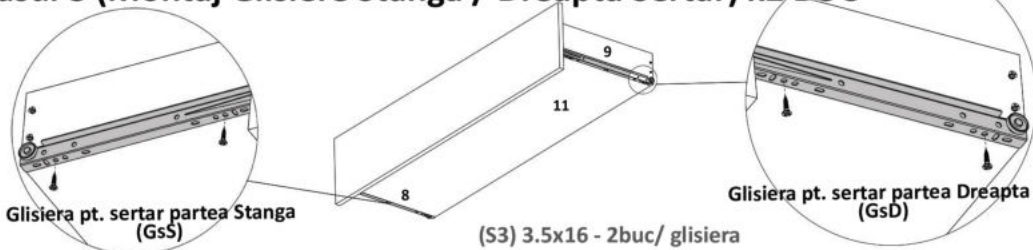

Instructiuni montaj: NOPTIERA EVEREST

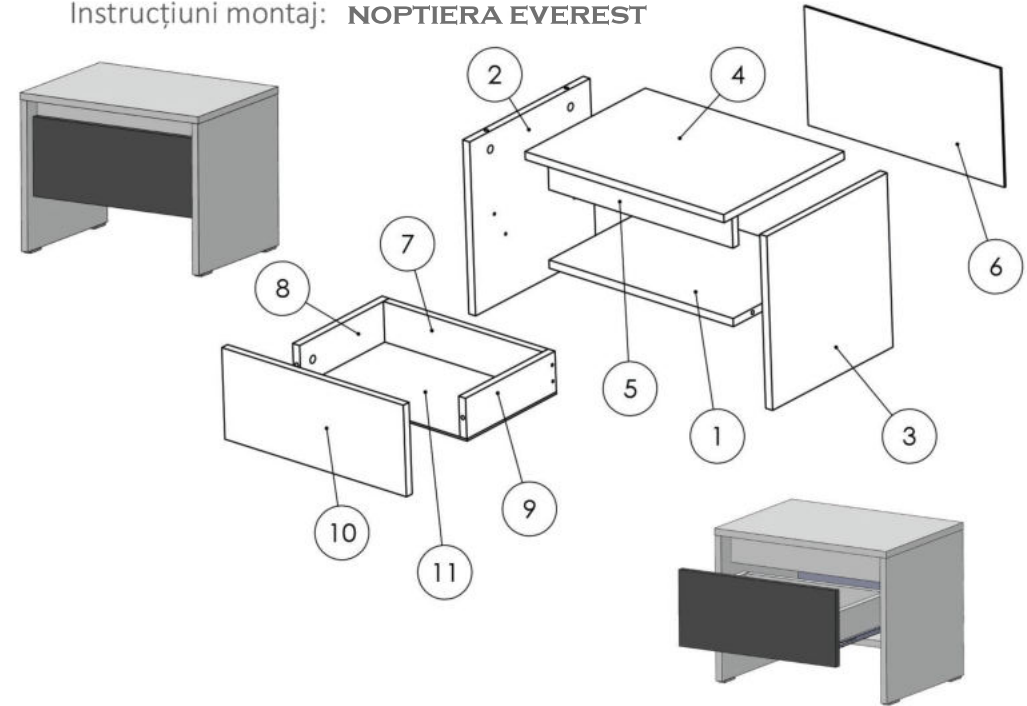

NR. REPER	DETALII	COD REPER	CANTITATE
1	PAL 428X300X16	FUND	1
2	PAL 342X336X16	LATERALA ST.	1
3	PAL 342X336X16	LATERALA DR.	1
4	PAL 462X336X16	TAVAN	1
5	PAL 428X70X16	LEZENA	1
6	HDF 456X234X16	HDF SPATE NOPTIERA	1
7	PAL 370X80X16	CAPAT SERTAR	1
8	PAL 250X80X16	LATERALA ST. SERTAR	1
9	PAL 250X80X16	LATERALA DR. SERTAR	1
10	PAL 422X180X16	FATA SERTAR	1
11	HDF 398X250X16	HDF FUND SERTAR	1

ATENȚIE: MONTAJUL NECORESPUNZĂTOR ATRAGE DUPĂ SINE PIERDEREA GARANȚIEI PRODUSULUI



Șurubelniță în cruce
sau autofiletantă











Este recomandat ca
montajul să fie făcut de
minim două persoane

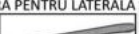

Un ciocan de dimensiune
medie

Elemente feronerie pentru 2X NOPTIERA:

DEMONTABIL CU EXCENTRIC De  24	PICIOR PLASTIC 5 mm Pi  8	SURUB 3.5X40 S6  8	CAMA Ca  24
CUIE Cu  60	CEP LEMN Ce  2	SURUB 3.5X16 S3  32	
GLISIERA PENTRU LATERALA ST. Gs  2 250 MM	GLISIERA PENTRU LATERALA DR. Gd  2 250 MM	GLISIERA PENTRU SERTAR ST. GSS  2 250 MM	GLISIERA PENTRU SERTAR DR. GSD  2 250 MM

Pasul 1 (MONTAJ ACCESORII X 2BUC)

Se bate cu ajutorul unui ciocan Cepuri de Lemn (Ce) x 2buc pe placa (4),
dupa care se monteaza (Gs) x 1 buc pe placa (2) si (Gd) x 1 buc pe placa (3),
fiecare cu cate 2 suruburi (S3).

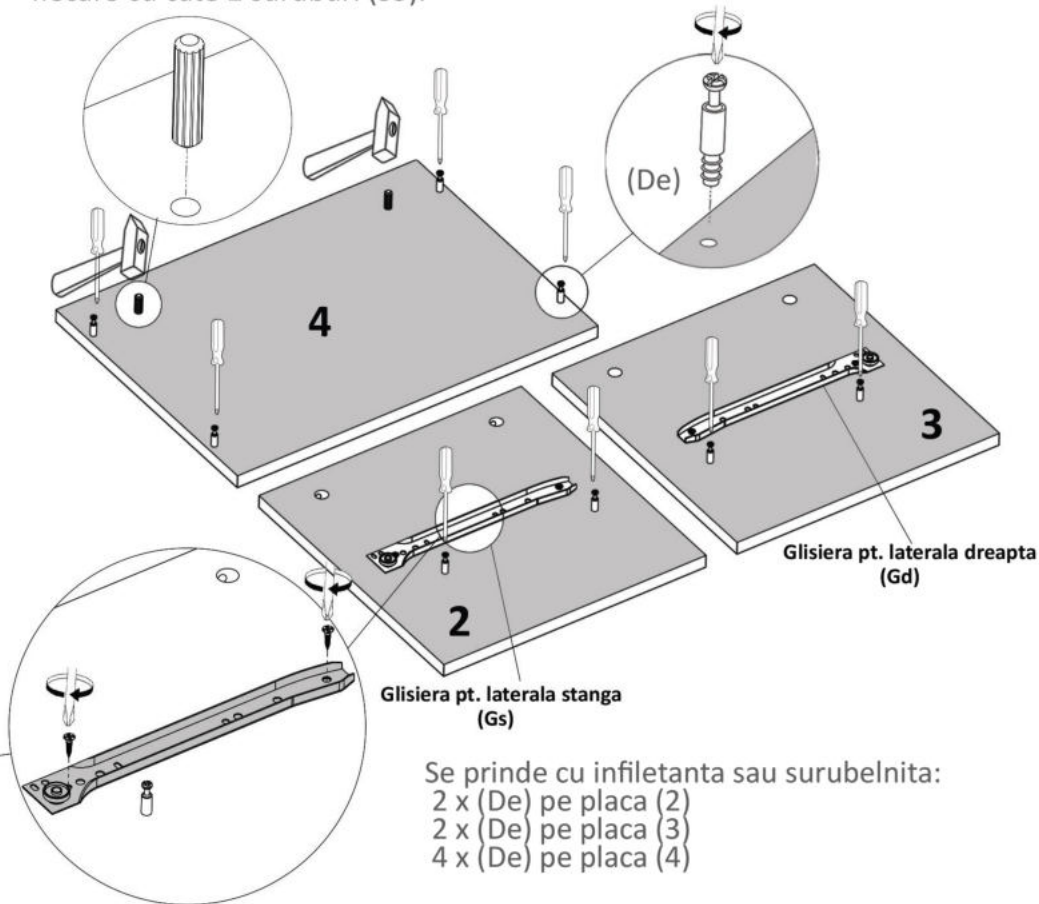

Pasul 2 (Montaj Repere) x 2BUC

Se pozitioneaza placa (5) in dreptul Cepurilor de lemn (Ce) dupa care se apasa
pana ce placile sau atins.

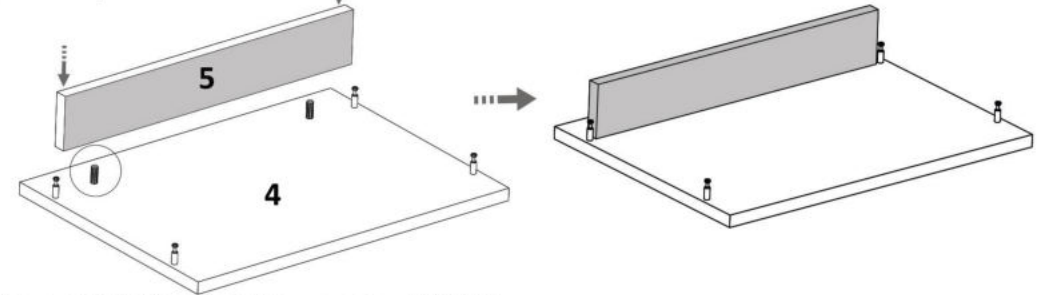

Pasul 3 (Montaj Repere) x 2BUC

Se prind placile laterale (2) si (3) de placa (1) cu demontabili (De) x 4 buc in
gaurile prestabilite, urmand ca apoi sa se infleteze (Ca) x 4 buc pana acestea
raman stranse.

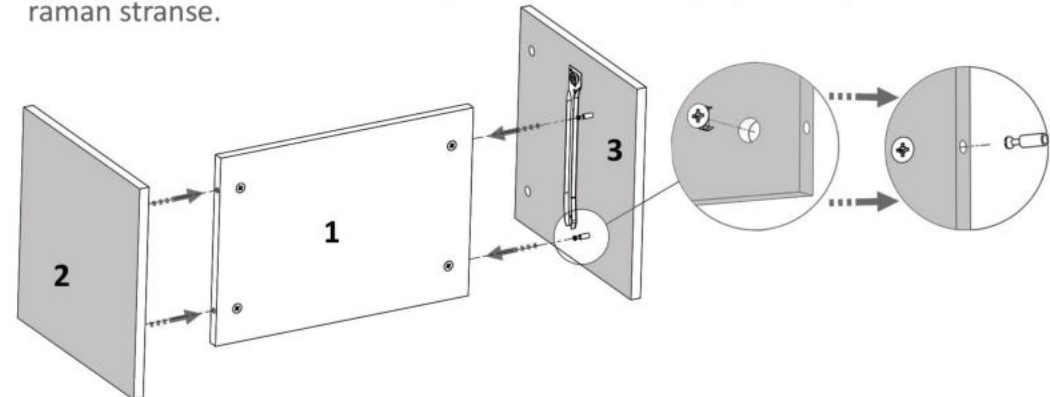

Pasul 4 (Montaj HDF)

Se masoara diagonalele sa fie in vinclu, dupa care se prinde HDF-ul (6) x 1 buc
folosindu-se de ciocan cu ajutorul unor cuie (Cu) x 60 buc.

