

COMODA GALARDO

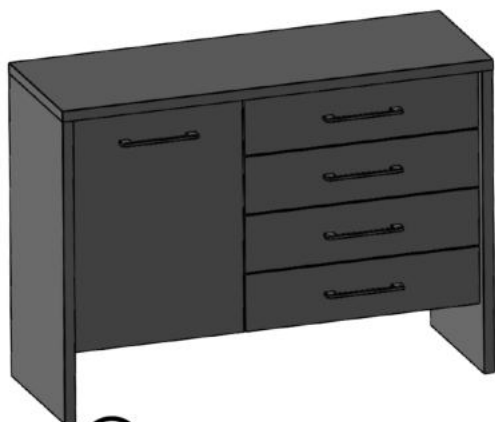

ATENȚIE!

Montajul necorespunzător atrage după sine, pierderea garanției produsului.



Acordați o atenție sporită!
Posibilitate de accidentare!



Reciclează obiectele vechi de mobilier și ambalajul produselor LAGUNA. Protejează natura!



LAGUNA
mobilă pentru acasă

MANER UR 160



5

KIT DEMONTABIL (tija + cama)



20

SURUB - 3.5 X 40 mm



16

SURUB M4 x 27 mm

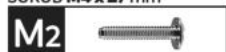

10

CUIE



72

SURUB - 3.5 X 16 mm

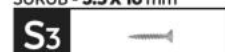

48

BALAMA INCADRATA



2

CONFIRMATOR 50mm

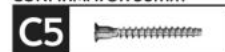

4

SAIBA TIP CUPA



3

TALPA / protecție podea



4

PROFIL "H" - imbinare HDF

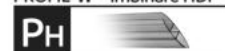

1

SET GLISIERE



3

- 1 Se montează **G** pe **PL** (dreapta) și **PI** prin 2 x **S3/G**
- 2 Se fixează **PF** de **PL stanga** și **PI** prin 4 x **K**
- 3 Se fixează **PL** cu **F** - prin 3 x **K**
- 4 Se fixează **PI** de **F** cu 2 x **C5**
- 5 Se fixează **TV (tavan)** de **PI, PL** cu 6 x **K**
- 6 Se aduce corpul la unghi de 90 și se fixează HDF spate cu **Q (cuie)**
- 7 Se montează usa, utilizând 2 x **Bi** și **S3 (4 x 2 Bi)**
- 8 Se montează manerul ușii, utilizând 4 x **M2, și MG**
- 9 Se montează **T** (talpi alunecătoare) de **PL** folosind 2 x **S3/T**

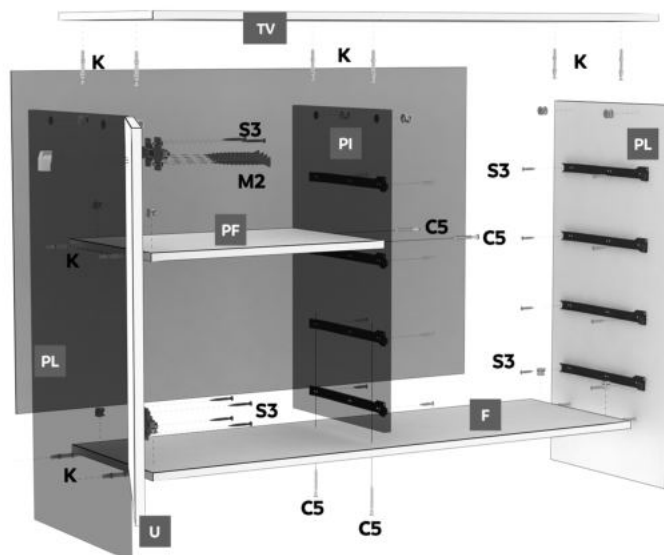

REPERE

SIMBOL	BUCATI	DENUMIRE
TV	1	TAVAN DIMENSIUNI REPER: 1154 X 406
F	1	FUND DIMENSIUNI REPER: 1096 X 367
PL	2	PERETE LATERAL DIMENSIUNI REPER: 807 X 406
PI	1	PERETE INTEREDIAR DIMENSIUNI REPER: 612 X 376
PF	1	POLITA FIXA DIMENSIUNI REPER: 454 X 367
U	1	USA DIMENSIUNI REPER: 622 X 458
FS	4	FATA SERTAR DIMENSIUNI REPER: 628 X 125
LS	8	LATERALE SERTAR DIMENSIUNI REPER: 350 X 100
CS	4	CAPAT SERTAR DIMENSIUNI REPER: 568 X 100

MONTAJUL SERTARELOR

- 1 Se fixează **LS** cu **CS** prin 4 x **S7**
- 2 Se fixează **LS** cu **FS** prin 2 x **K**
- 3 Se fixează **G (glisierile)** cu **S3**
- 4 Se fixează **MG (maner)** cu 4 x **M2**
- 5 Se aduce sertarul la unghi de 90 și se fixează fundul de sertar cu **Q (cuie)**

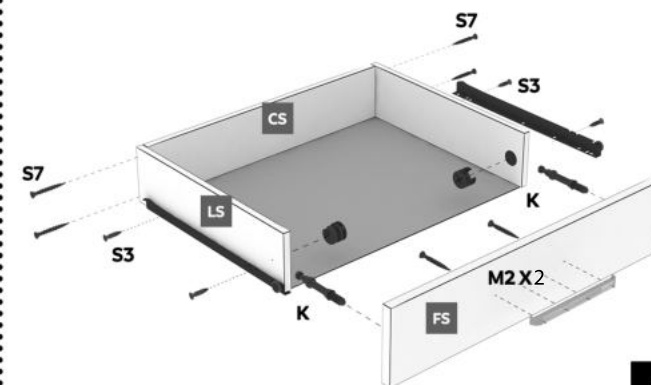

1