















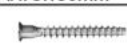





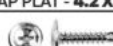

INSTRUCTIUNI DE ASAMBLARE

DRESSING GALARDO 185

PROFIL RULARE SINA PR  2	PROFIL "U" PU  1	KIT DEMONTABIL (tija + cama) K  16	SURUB - 3.5 X 40 mm S7  8	TALPA / protectie podea T  7
SET GLISIERE G  2	PROFIL "S" PS  1	CONFIRMATOR 50mm C5  60	SURUB - 3.5 X 16 mm S3  36	CEP LEMN W  16
PLACUTA "I" i  16	PROFIL "Y" PY  2	CUIE Q  116	SURUB CAP PLAT - 4.2 X 16 mm X9  12	SUPORT POLITA MOBILA P  12
BARA HAINE + SUPORTI BARA H  1	PROFIL "H" - imbinare HDF PH  2	SISTEM DE GLISARE SG  8	AUTOCOLANTE BULINE Ac  6	STICLUTA ARACET AR  1
SUPORT INTERMEDIAR BARA HAINE Hi  1				

REPERE

SIMBOL	BUCATI	DENUMIRE	SIMBOL	BUCATI	DENUMIRE	SIMBOL	BUCATI	DENUMIRE
T	1	TAVAN DIMENSIUNI REPER: 1938 X 600	PM	2	POLITE MOBILE DIMENSIUNI REPER: 783 X 500	PFT	1	PROFIL TAVAN DIMENSIUNI REPER: 1780 X 30 X 22
F	1	FUND DIMENSIUNI REPER: 1804 X 600	DS	1	DESPARTITOR SUS DIMENSIUNI REPER: 600 X 368	SFS	2	FRONT SERTAR DIMENSIUNI REPER: 680 X 154
PL	2	PERETI LATERALI DIMENSIUNI REPER: 2140 X 600	DJ	2	DESPARTITOR JOS DIMENSIUNI REPER: 484 X 368	SLS	4	LATERALE SERTAR DIMENSIUNI REPER: 450 X 120
PI	1	PERETE INTERMEDIAR DIMENSIUNI REPER: 2024 X 500	S	2	SOCLU MARE DIMENSIUNI REPER: 1804 X 100	SCS	2	CAPAT SERTARE DIMENSIUNI REPER: 590 X 120
PFM	2	POLITE FIXE MARI DIMENSIUNI REPER: 1005 X 500	SM	1	SOCLU MIC DIMENSIUNI REPER: 537 X 100	SU	10	SEGMENTI USA DIMENSIUNI REPER: 400 X 922
PF	2	POLITE FIXE DIMENSIUNI REPER: 783 X 500	PFL	2	PROFILE LATERALE DIMENSIUNI REPER: 2157 X 30 X 25	HDF	3	PROFILE HDF PRINDERE PE SPATE CU (Q) CUIE

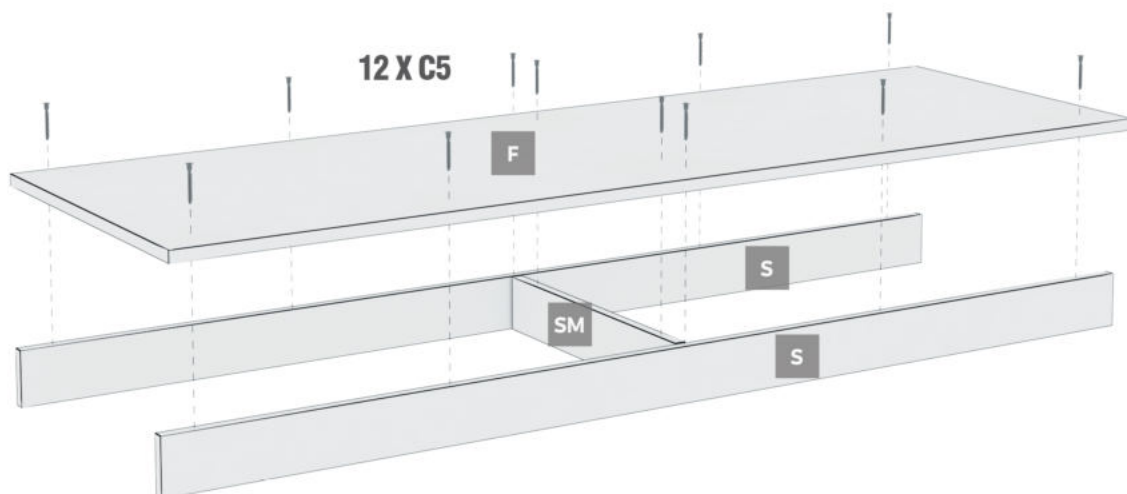
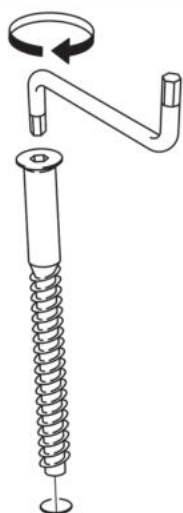

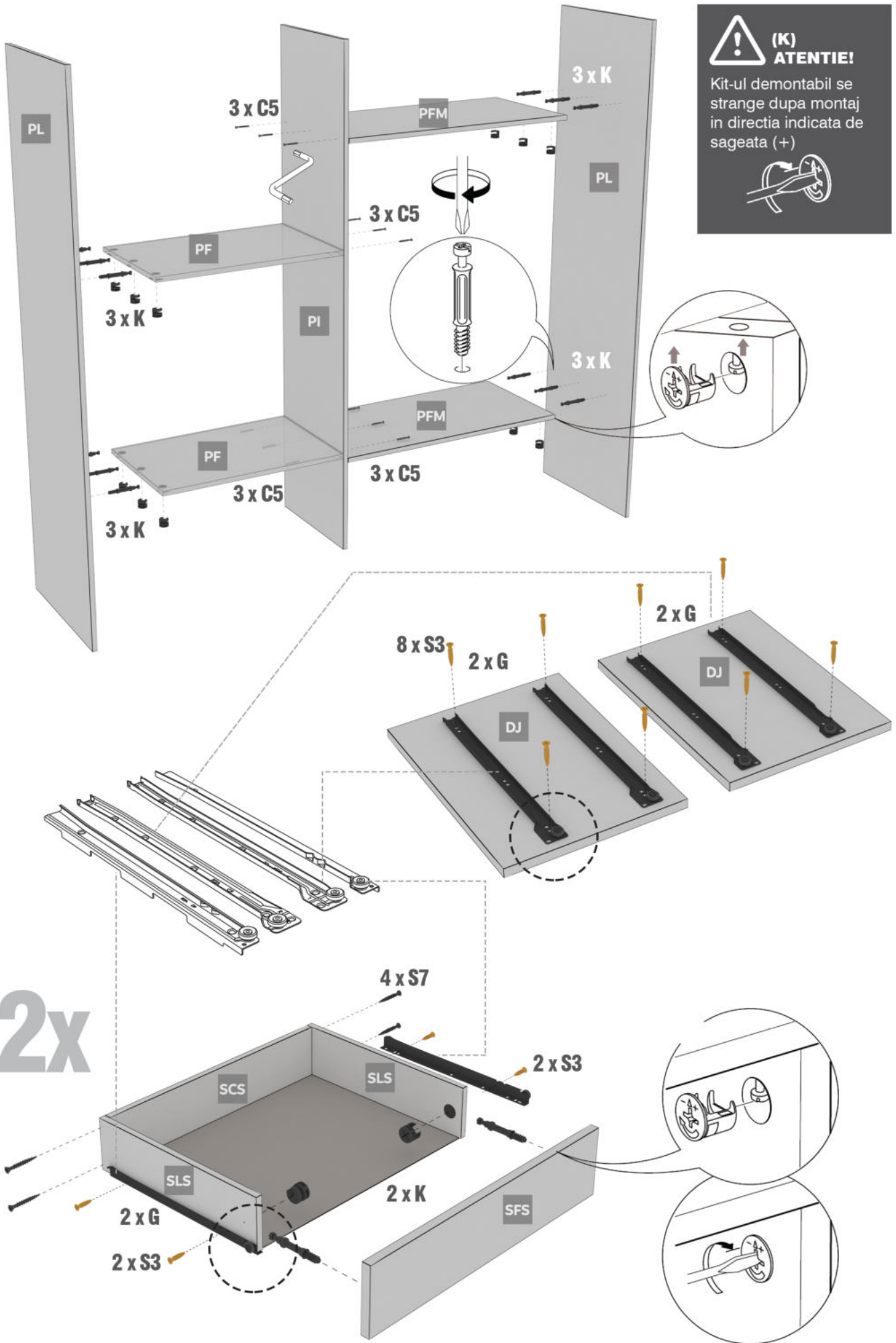

(K) ATENTIE!

Kit-ul demontabil se strange dupa montaj in directia indicata de sageata (+)



2x

4 x S7

2 x S3

2 x G

2 x S3

2 x K

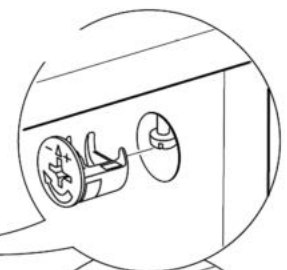

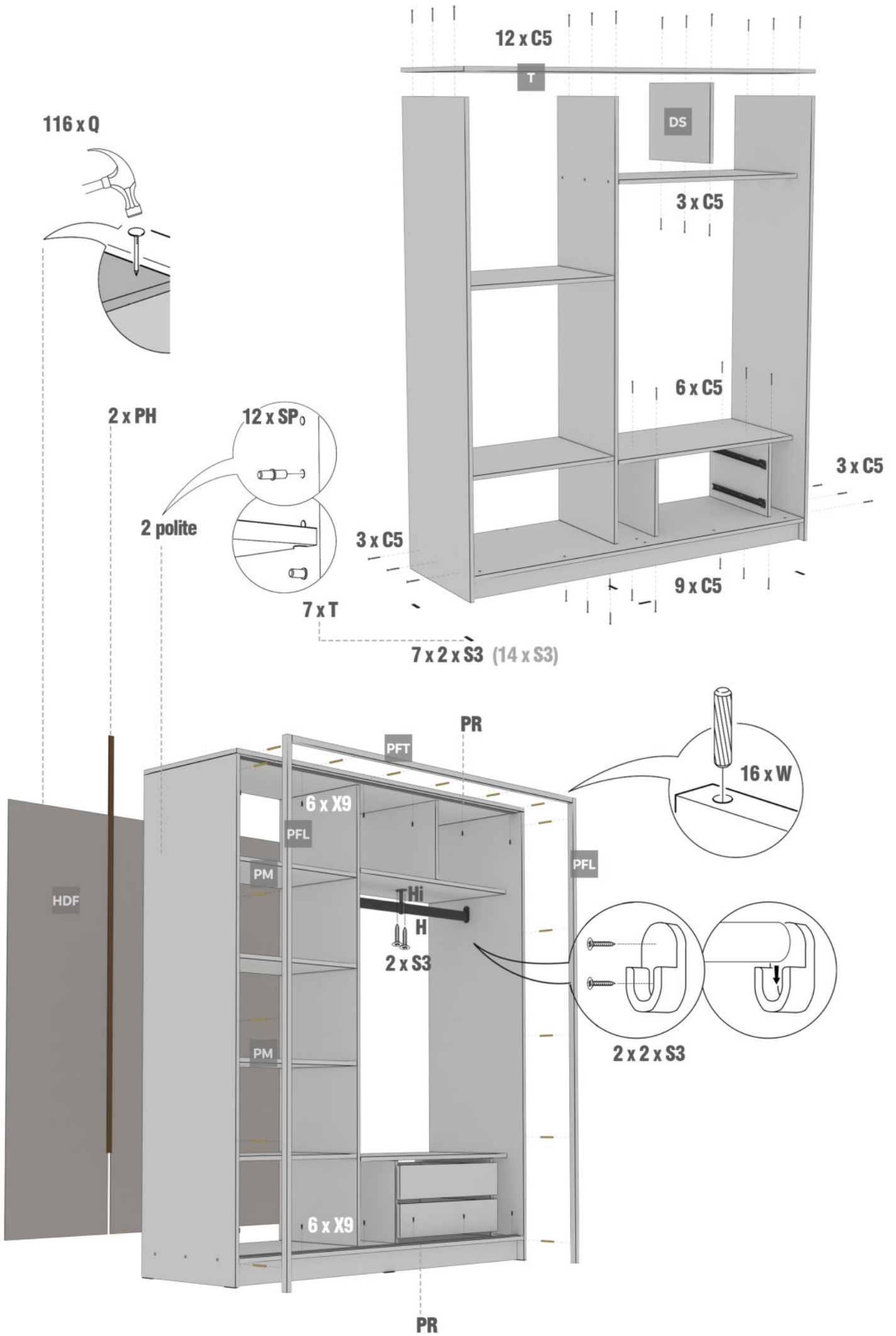

FERONERIE USI

(PAL, MDF, PAL+MDF,
OGLINA+PAL, OGLINDA +MDF)

SURUB - 3.5X16 mm



SURUB - 3.5X12 mm



FERONERIE USI

(5 SEGMENTI OGLINDA)

SURUB - 3.5X12 mm



SURUB M4 x10 mm

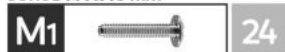

BUCSA DUBLU FILET M4/8/10 - 434.01.00

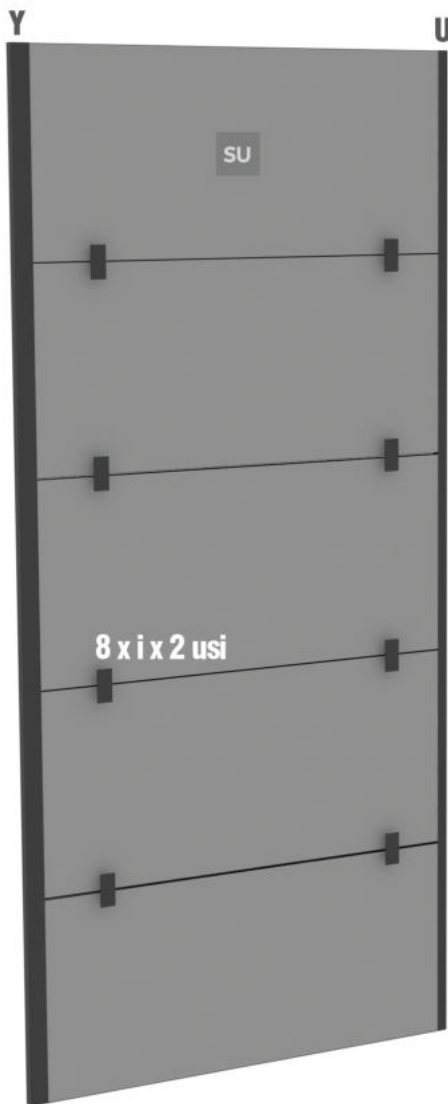

ATENȚIE!

Profilele se prind de segmentii de 16 mm cu surub S3 de 3.5x16

In cazul in care segmentul este de 12 mm + Oglinda sau Print se vor folosi surube de 3.5x12



ATENȚIE!

Posibilitate mare de a gresi surubele de 3.5x16 cu cele de 3.5x12



ATENȚIE!

Placuta I se va prinde cu surube de 3,5x12 de segmentul de 12 mm +oglanda sau print

Placuta I se va prinde cu surub de 3.5x16 de segmentul de 16 mm

In functie de grosimea palului 12 mm sau 16 mm se va folosi suruburi de 12 mm respectiv 16 mm



ATENȚIE!

Sistemul de rulare (SG) se va prinde de Segmentul 1 si 5 cu surube de 3.5x16 daca segmentul este de 16 mm.

Daca segmentul de pal este de 12 mm + Oglinda se vor folosi bucele de fier de 10 mm + suruburile aferente lor.



ATENȚIE!

Montarea necorespunzatoare cu schita de montaj atrage dupa sine pierderea garantiei!

perie praf

